

L1[®] PORTABLE LINE ARRAY SYSTEMS



The Bose[®] L1 portable line array systems use proprietary technology to deliver clear, powerful sound throughout the entire listening area – even off to the extreme sides.



Quick Comparison Overview

	L1 [®] Model II system	L1 [®] Model 1S system	L1 [®] Compact system
Positioning	Our most advanced system featuring our 24-speaker articulated line array providing our best tonal balance, coverage, and highest output.	A unique combination of performance and portability that includes our 12-speaker articulated line array providing smooth tonal balance, coverage, and high output.	Our smallest, lightest and easiest-to-set-up L1 system featuring a 6-speaker curved articulated line array providing smooth tonal balance and coverage, weighing just 29 pounds.
Audience size	Up to 500	Up to 300	Up to 100
Acoustic performance	The articulated 24-speaker line array provides 180 degrees of horizontal sound coverage while at the same time offering extremely tight vertical control resulting in less drop off in volume over distance than conventional loudspeakers.	The 12-speaker articulated line array provides 180 degrees of horizontal sound coverage while at the same time offering tight vertical control resulting in less drop off in volume over distance than conventional loudspeakers.	The L1 Compact loudspeaker array is smaller than those in the L1 Model IS and Model II systems, yet produces comparable horizontal sound coverage. The L1 Model IS and Model II systems project sound further and with less volume drop-off than the L1 Compact system.
Coverage	180° H x 0° V	180° H x 10° V	180° H x 40° V
Max SPL	115 dB (Cont), 121 dB (Peak)	112 dB (Cont), 118 dB (Peak)	106 dB (Cont.), 112 dB (Peak)
Low Frequency	40 Hz		65 Hz
Bass	The Model II power stand can drive two B1 bass modules or a single B2 bass module. It also features a dedicated bass line out allowing it to be used with the A1 PackLite [®] amplifier to add two additional B1 bass modules or an additional B2 bass module.	The Model 1S power stand can drive two B1s or a single B2 bass module.	The L1 Compact system features an integrated bass speaker in the power stand. <i>It is not compatible with the B1 or B2 bass modules.</i>
I/O	<ul style="list-style-type: none"> • 1 x 1/4" analog input • 1 x NL4 bass module out • 1 x ToneMatch[®] port • 1 x trim control • 1 x power switch • 1 x 1/4" bass line out 	<ul style="list-style-type: none"> • 1 x 1/4" analog input • 1 x NL4 bass module out • 1 x ToneMatch port • 1 x trim control • 1 x power switch 	<ul style="list-style-type: none"> • 1 x microphone input • 1 x 1/8" balanced analog input • 1 x RCA stereo input • 1 x 1/4" analog input • 1 1/4" mono analog output • 1 x RCA output
System includes	<ul style="list-style-type: none"> • L1 Model II top and bottom loudspeaker arrays • L1 Model II system power stand • AC power cord • Protective carrying bags/covers • B1 or B2 bass module with cable and slip cover 	<ul style="list-style-type: none"> • L1 Model 1S top array and bottom extension • L1 Model 1S power stand • AC power cord • Protective carrying bags/covers • B1 or B2 bass module with cable and slip cover 	<ul style="list-style-type: none"> • L1 Compact loudspeaker array • L1 Compact system power stand with slip cover • L1 Compact system extensions with protective carry bag

APPLICATION GUIDE

L1[®] PORTABLE LINE ARRAY SYSTEMS

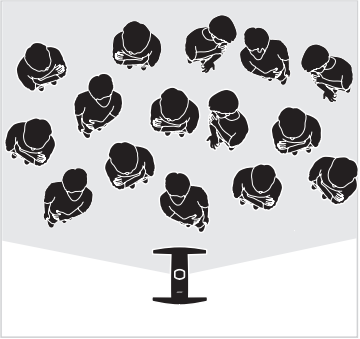
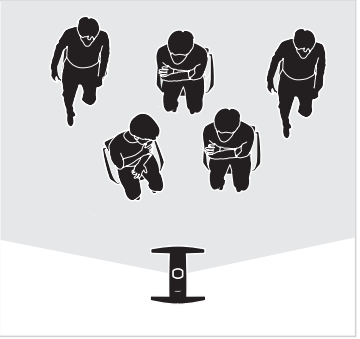
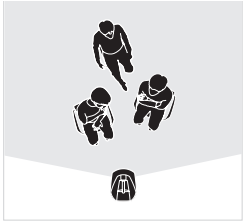
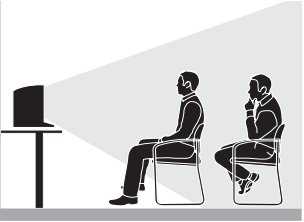
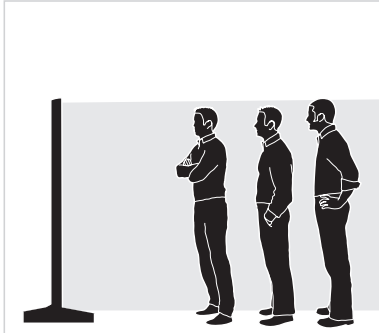
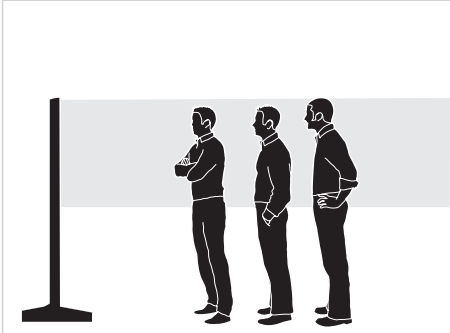
Sound Coverage

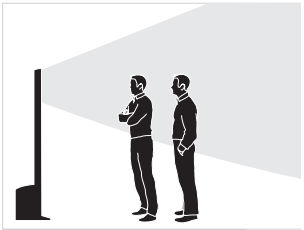
L1 [®] Model II system	L1 [®] Model 1S system	L1 [®] Compact system
<p>Audience size: Up to 500</p>  <p>TOP</p>	<p>Audience size: Up to 300</p>  <p>TOP</p>	<p>Audience size: Up to 100</p>  
 <p>SIDE</p>	 <p>SIDE</p>	<p>Extended Position</p>  

L1[®] PORTABLE LINE ARRAY SYSTEMS

The Bose[®] L1 portable line array systems' combination of performance, portability and easy setup makes them an ideal solution for many situations.

Venue		Recommended System	Possible Applications (by audience size)			
Education	<ul style="list-style-type: none"> Classrooms Auditoriums Gymnasiums Cafeterias Outdoors 	L1[®] Compact system Small sized audience up to 100 people	Augmented audio for viewing a movie	Presenting audio from a PC	Listening to a blog or podcast	Audio for a SMART Board™ interactive whiteboard
		L1[®] Model 1S system Mid sized audience up to 300 people	Rallies, sporting events, speeches,	Plays and indoor performances	Announcements and music at practices	Emergency preparedness drills
		L1[®] Model II system Large sized audience up to 500 people				
Hospitality	<ul style="list-style-type: none"> Ballrooms Conference rooms Meeting rooms Hotel common areas 	L1[®] Compact system Small sized audience up to 100 people	Special event, anniversary Presentation or speech at a banquet or corporate meeting Bookstore cafe	Business presentation		
		L1[®] Model 1S system Mid sized audience up to 300 people		Conference room meeting		
		L1[®] Model II system Large sized audience up to 500 people		Outdoor cocktail party		
Houses of Worship	<ul style="list-style-type: none"> Indoor public address Lobby and hallways Youth rooms Cafe/Bookstore Classrooms and offices Portable church 	L1[®] Compact system Small sized audience up to 100 people	Secondary PA for retreats and mission work Secondary PA or backline for worship band, PA for youth events Secondary PA for music worship	Activity room/Sm. function room	Memorial services	
		L1[®] Model 1S system Mid sized audience up to 300 people		Raffles, bingo games, or other events		
		L1[®] Model II system Large sized audience up to 500 people				
Business and Civic	<ul style="list-style-type: none"> Offices Public address Training/classes Meetings 	L1[®] Compact system Small sized audience up to 100 people		Corporate presentations	Training and demonstration	Exercise/fitness classes (karate, dance, aerobics, etc.)
		L1[®] Model 1S system Mid sized audience up to 300 people	Public speaking, announcement		Fitness center gymnasium	
		L1[®] Model II system Large sized audience up to 500 people	Outdoor community events, community theater		Radio remote broadcast at a large concert or event	
Military/Law Enforcement	<ul style="list-style-type: none"> Indoor events Outdoor events Training 	L1[®] Compact system Small sized audience up to 100 people	Briefings, press events, and training exercises, municipal auctions		Portable crowd control or public address	
		L1[®] Model 1S system Mid sized audience up to 300 people	Training exercises, outdoor municipal auctions, crowd control			
		L1[®] Model II system Large sized audience up to 500 people				
Consumer	<ul style="list-style-type: none"> Parties Outdoor events General music/voice amplification 	L1[®] Compact system Small sized audience up to 100 people	Backyard parties Special family events	Football parking lot tailgating	Karaoke parties at home	DJ amplification
		L1[®] Model 1S system Mid sized audience up to 300 people	Outdoor amateur sports events Theatrical production, soundstage/sound effect (SFX)			
		L1[®] Model II system Large sized audience up to 500 people				

L1[®] SYSTEMS FOR AUDIENCE SIZE: up to 100

L1[®] Compact portable line array system

Our smallest, lightest and easiest-to-set-up L1 system featuring a 6-speaker curved articulated line array providing smooth tonal balance and coverage, weighing just 29 pounds.

The L1 Compact loudspeaker array is smaller than those in the L1 Model IS and Model II systems, yet produces comparable horizontal sound coverage. The L1 Model IS and Model II systems project sound further and with less volume drop-off than the L1 Compact system.

The L1 Compact system features an integrated bass speaker in the power stand. *It is not compatible with the B1 or B2 bass modules.*

These durable components easily connect without the need for speaker stands or wires and are readily transported in two protective carry bags/covers. The materials and construction are specifically designed to meet the performance demands of a wide range of applications including musical performances, music playback, speeches and AV sound reproduction.

The L1 Compact system can be operated in two modes:

Collapsed Tabletop

For smaller gatherings and meetings

Extended Position

For larger audiences

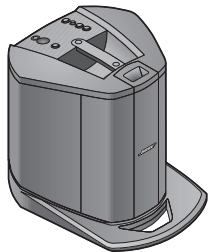

Collapsed Tabletop

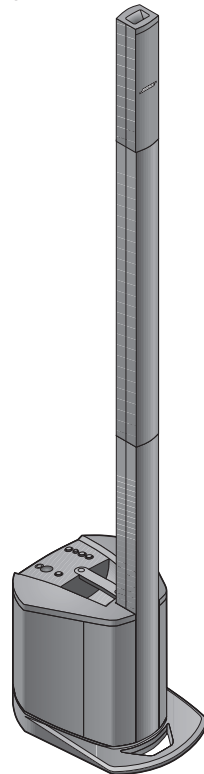

Extended Position

Sound Coverage

Collapsed Tabletop

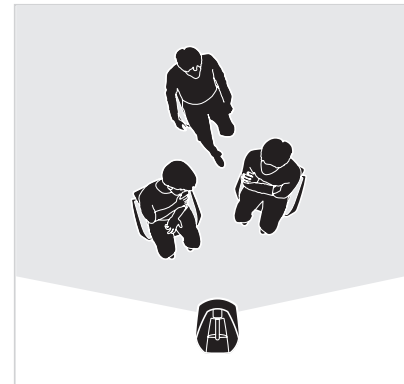

TOP

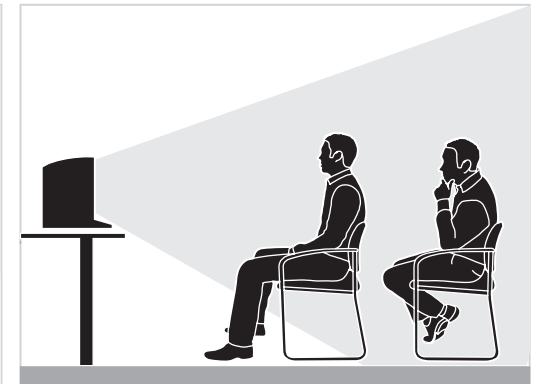

SIDE

Extended Position

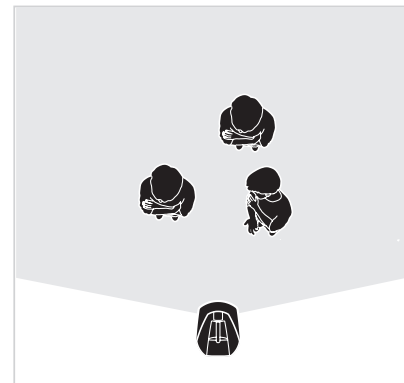

TOP

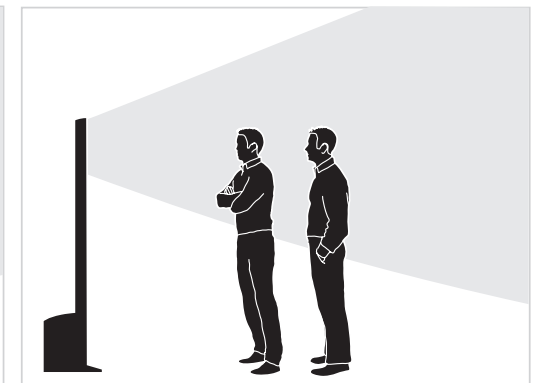

SIDE

L1[®] SYSTEMS FOR AUDIENCE SIZE: up to 100

Application example 1 — Voice Amplification

Applications

Secondary PA for retreats and mission work, youth room

Memorial services

Public speaking/announcement

Corporate presentations

Training and demonstration

Briefings, press events, and training exercises

Municipal auctions

Portable crowd control or public address

Football parking lot tailgating



TV



DVD/video



MP3 player



Laptop/PC



Microphone



Instrument



SMART Board
interactive whiteboard



Projector

L1[®] SYSTEMS FOR AUDIENCE SIZE: up to 100

Application example 2 — Music or Audio Playback

Applications

Presenting audio from a PC

Listening to a blog or podcast

Business presentation

Backyard parties, special family events

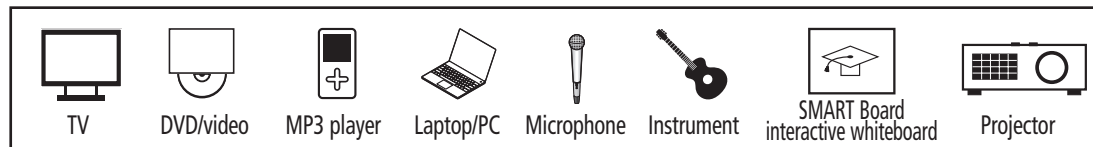
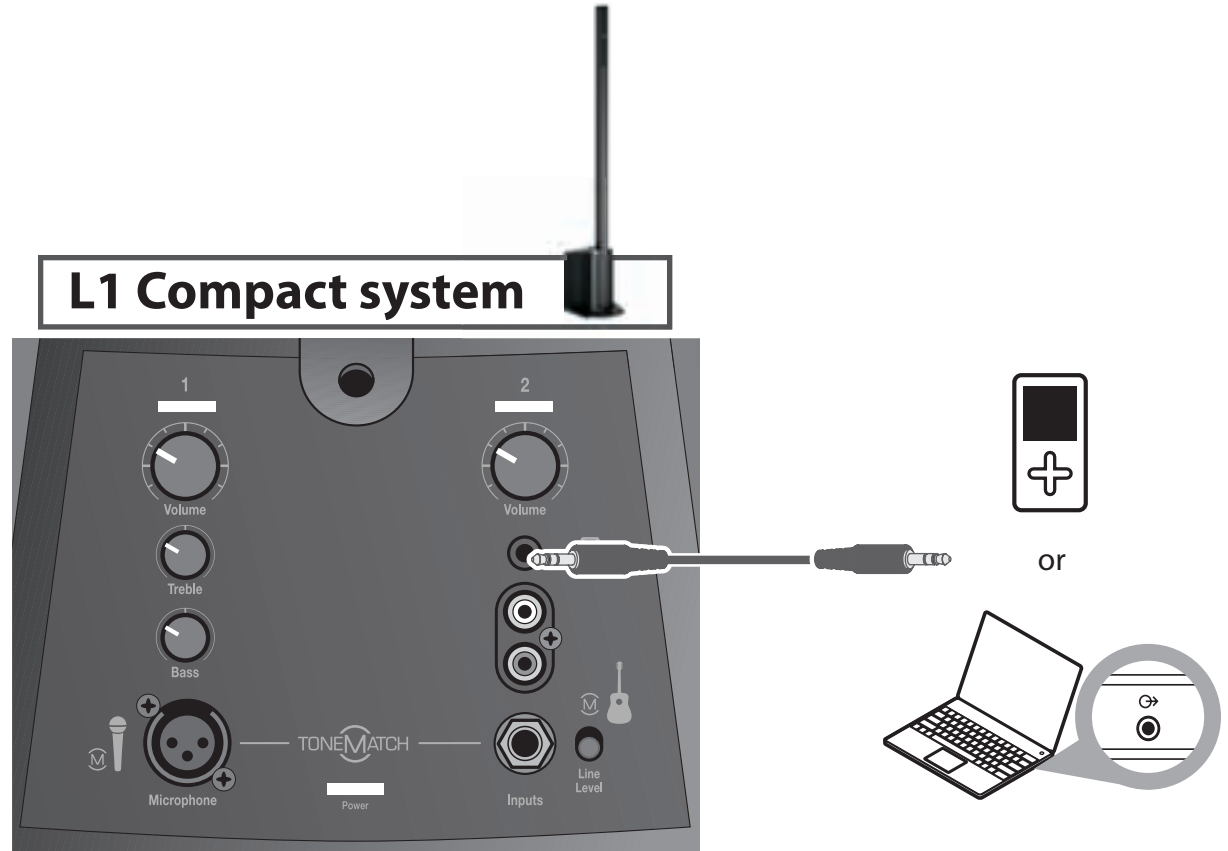

L1[®] SYSTEMS FOR AUDIENCE SIZE: up to 100

Application example 3 — Voice Amplification with Music or Audio Playback

Applications

Special Event, anniversary, other

Business presentation (in a small ballroom or conference space)

Exercise/fitness classes (karate, dance, aerobics, etc.)

Activity room/small function room

Backyard parties/special family events

Karaoke parties at home

DJ amplification

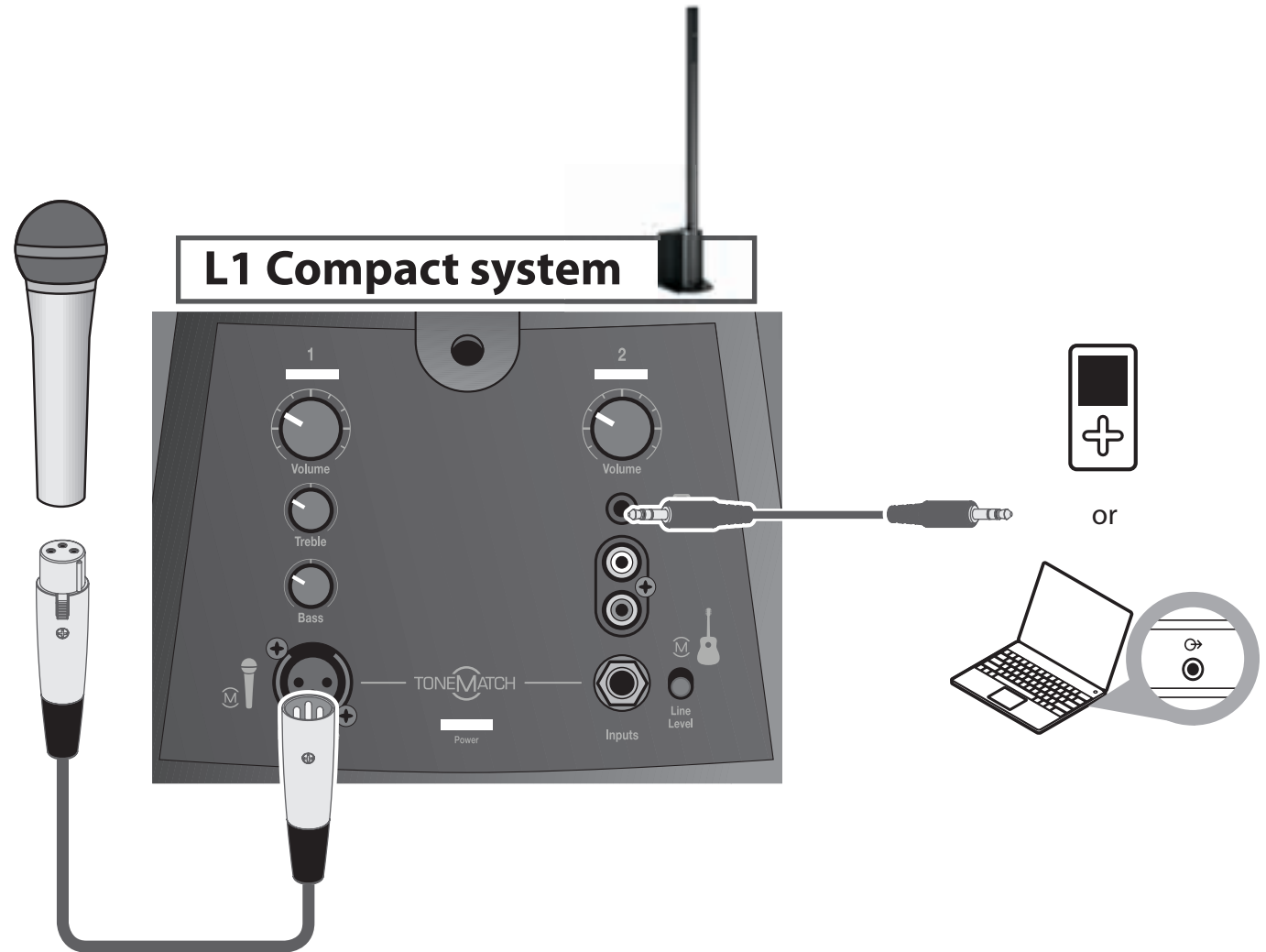

TV



DVD/video



MP3 player



Laptop/PC



Microphone



Instrument



SMART Board
interactive whiteboard



Projector

L1[®] SYSTEMS FOR AUDIENCE SIZE: up to 100

Application example 4 — Audio Playback with Video

Applications

Audio augmentation for a SMART Board interactive whiteboard

Family movie night outdoors

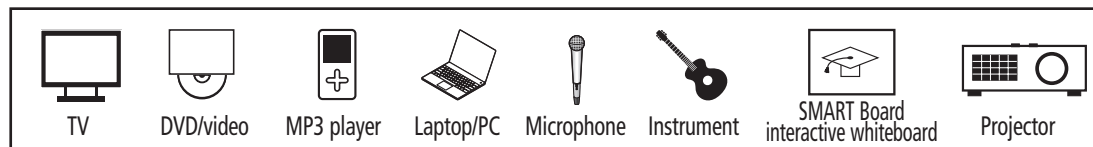
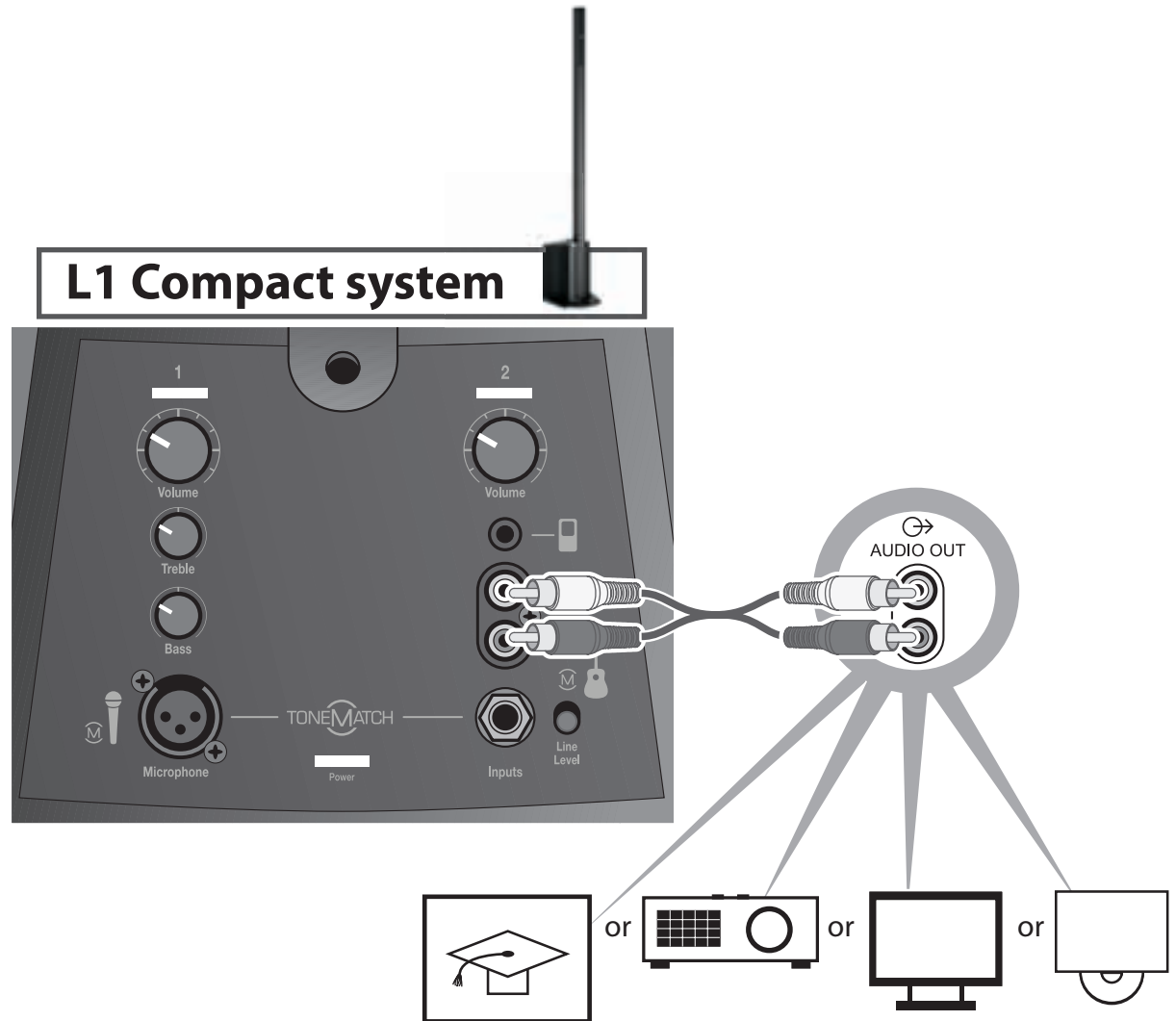

L1[®] SYSTEMS FOR AUDIENCE SIZE: up to 100

Application example 5 — Voice Amplification with Music or Audio Playback and Musical Instrument

Applications

Secondary PA or backline for worship band

Bookstore cafe

Memorial services

Backyard parties/special family events

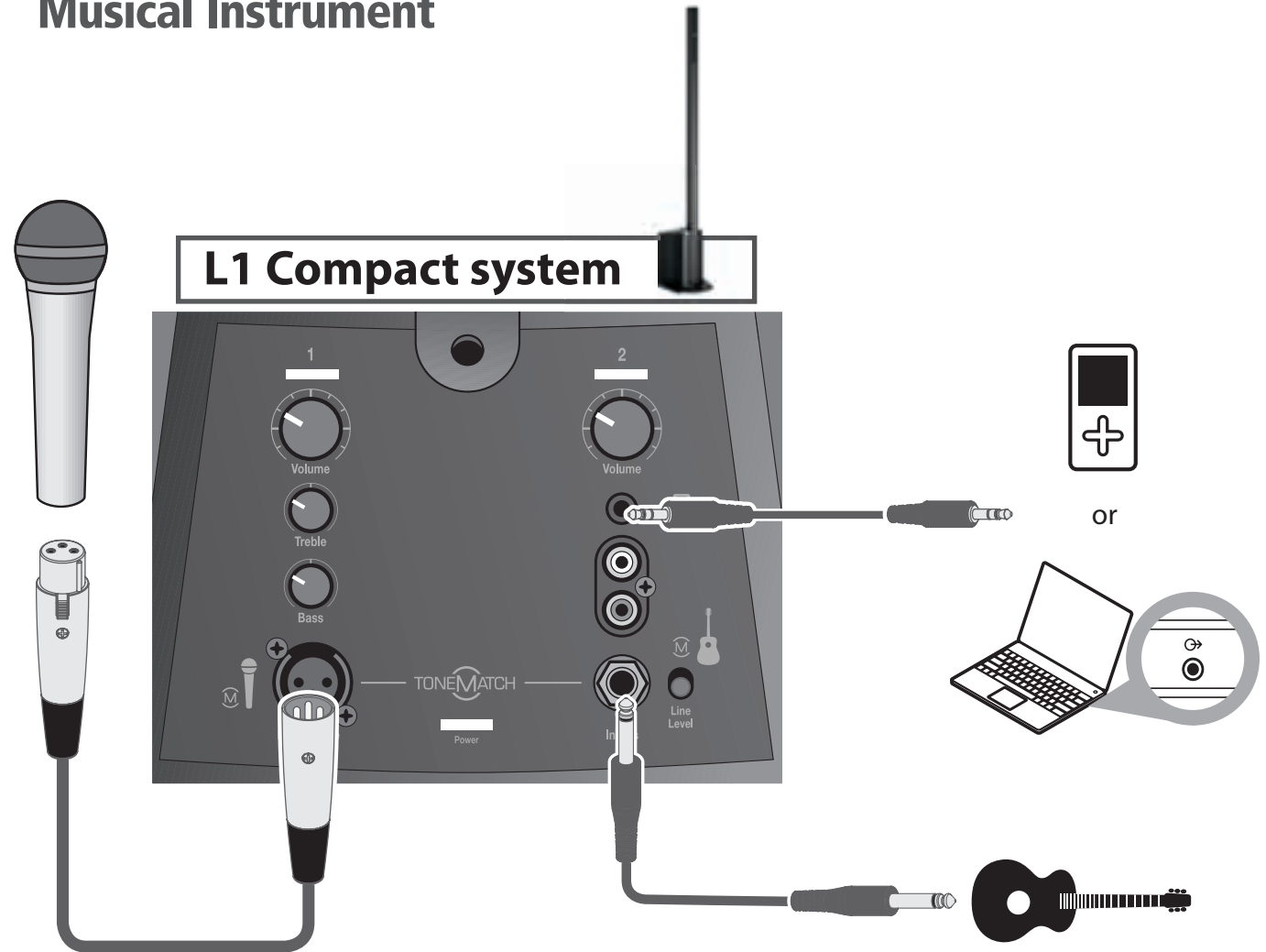

TV



DVD/video



MP3 player



Laptop/PC



Microphone



Instrument



SMART Board
interactive whiteboard



Projector

L1[®] SYSTEMS FOR AUDIENCE SIZE: up to 300

L1[®] Model 1S portable line array system

A unique combination of performance and portability that includes our 12-speaker articulated line array providing smooth tonal balance, coverage, and high output.

The 12-speaker articulated line array provides 180 degrees of horizontal sound coverage while at the same time offering tight vertical control resulting in less drop off in volume over distance than conventional loudspeakers.

The Model 1S power stand can drive two B1s or a single B2 bass module.

These durable components easily connect without the need for speaker stands or wires and are readily transported in three protective carry bags/covers. The materials and construction are specifically designed to meet the performance demands of a wide range of applications including musical performances, music playback, speeches and AV sound reproduction.

Bass Modules

Users have a choice between the B1 portable, lightweight bass module, or the B2 high-performance, flexible bass module.

T1 ToneMatch[®] Audio Engine

The addition of a T1 ToneMatch Audio Engine to any of the L1 systems provides four input channels with independent selection of ToneMatch presets and effects, including customized ToneMatch presets for a variety of popular microphones and instruments.

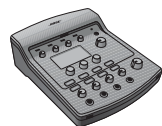

T1 ToneMatch[®]
Audio Engine

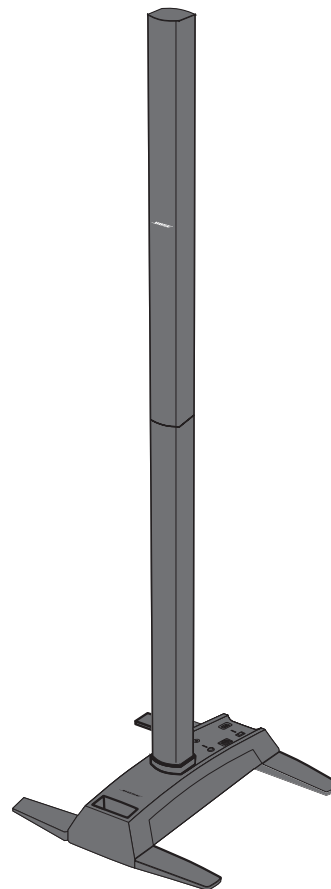

L1[®] Model 1S

Sound Coverage

L1[®] Model 1S

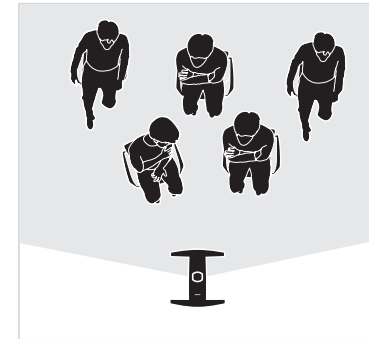

TOP

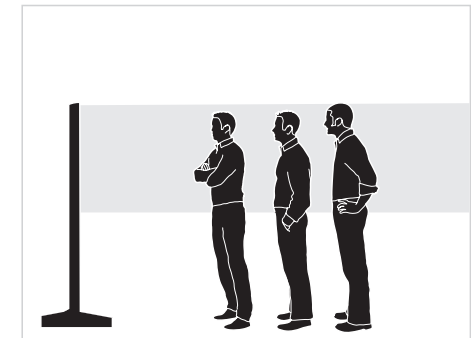

SIDE

L1® SYSTEMS FOR AUDIENCE SIZE: up to 300

Application example 1 — Voice Amplification

Applications

Plays and indoor performances

Emergency preparedness drills

Raffles, bingo games, or other events

Training exercises

Outdoor municipal auctions

Crowd control

L1 Model 1S system

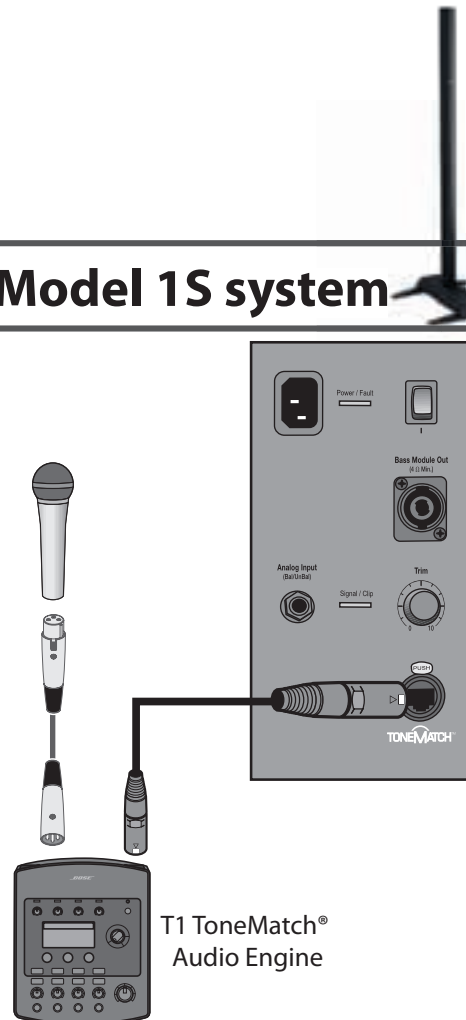

Sound Coverage

L1® Model 1S

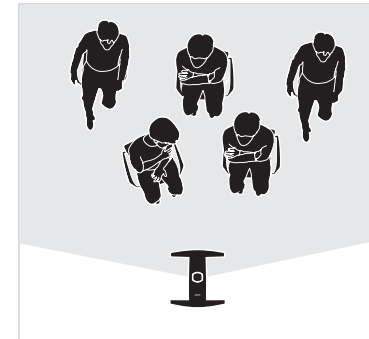

TOP

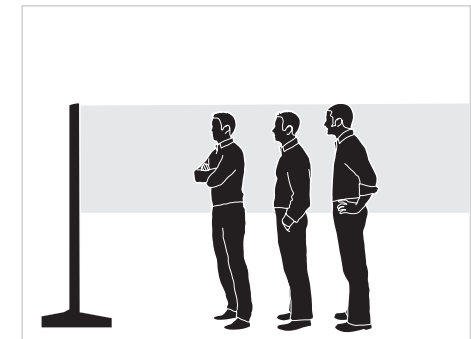

SIDE



TV



DVD/video



MP3 player



Laptop/PC



Microphone



Instrument



SMART Board
interactive whiteboard



Projector

L1[®] SYSTEMS FOR AUDIENCE SIZE: up to 500

Application example 2 — Music or Audio Playback

Applications

Outdoor cocktail party

Soundstage/sound effect (SFX)

L1 Model 1S system

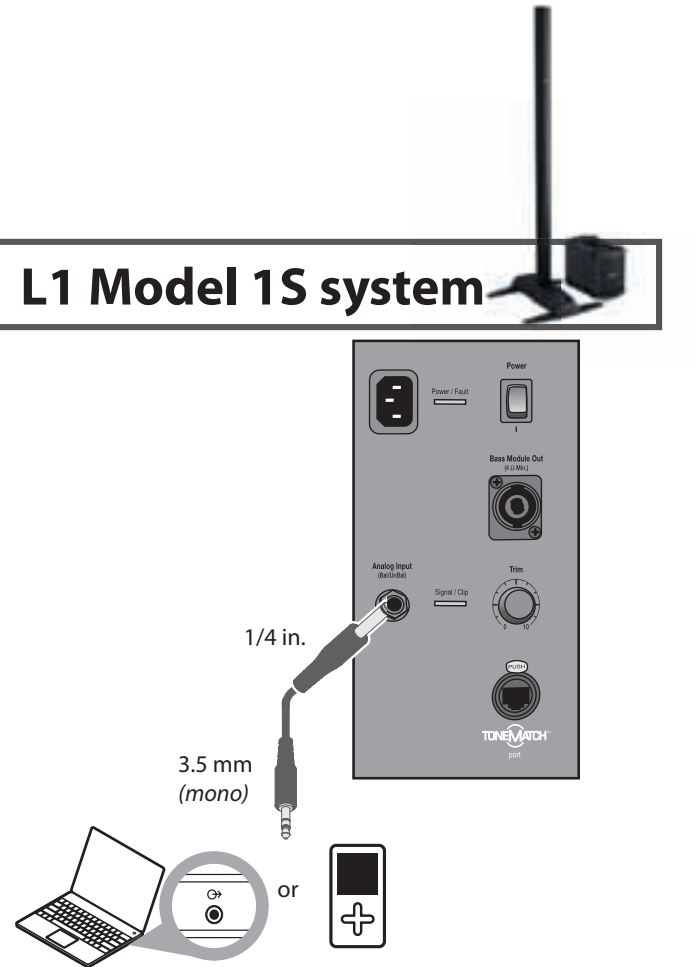

Sound Coverage

L1[®] Model 1S

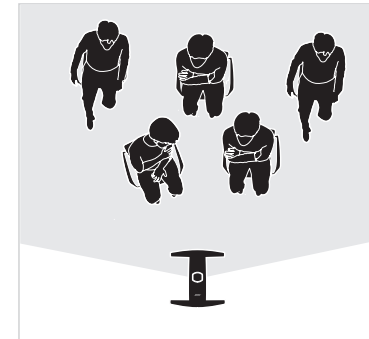

TOP

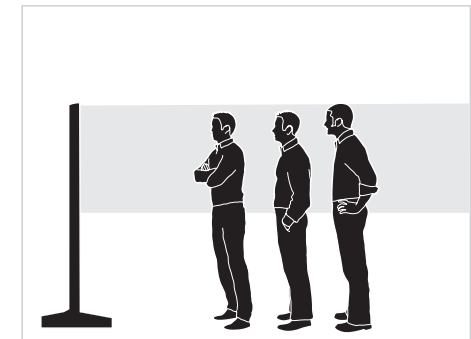

SIDE

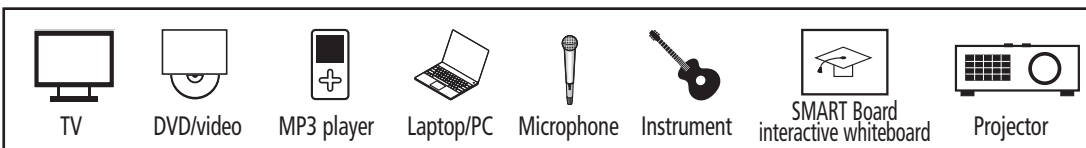

L1® SYSTEMS FOR AUDIENCE SIZE: up to 300

Application example 3 — Voice Amplification with Music or Audio Playback

Applications

Rallies, sporting events, speeches

Announcements and music at practices

Presentation or speech at a banquet or corporate meeting

Conference room meeting

Outdoor community events

Community theater

Fitness center gymnasium

Radio remote broadcast at a large concert or event

Outdoor amateur sports events

Theatrical production

L1 Model 1S system

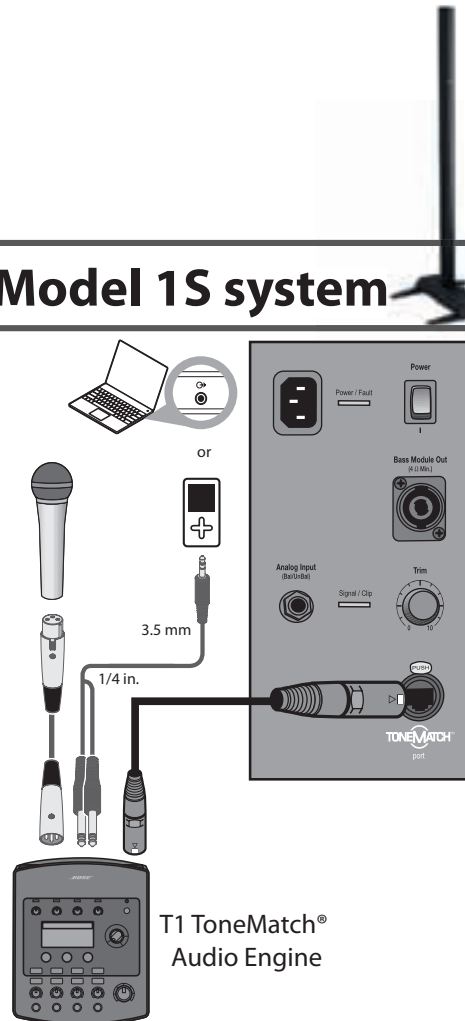

T1 ToneMatch® Audio Engine

Sound Coverage

L1® Model 1S

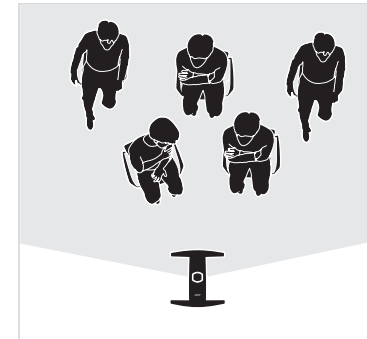

TOP

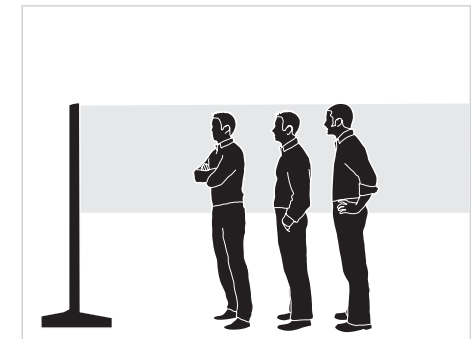

SIDE

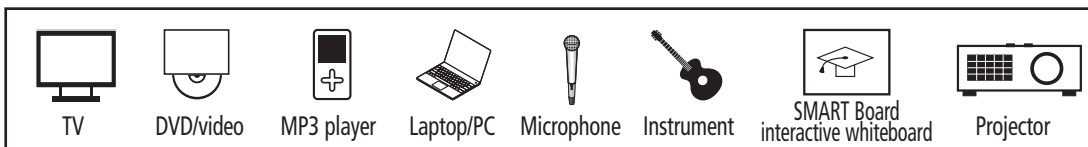

L1[®] SYSTEMS FOR AUDIENCE SIZE: up to 300

Application example 4 — Voice Amplification with Music or Audio Playback and Musical Instrument

Applications

Secondary PA for music worship, etc.

Community theater

Announcements and music at practices

Plays and indoor performances

L1 Model 1S system

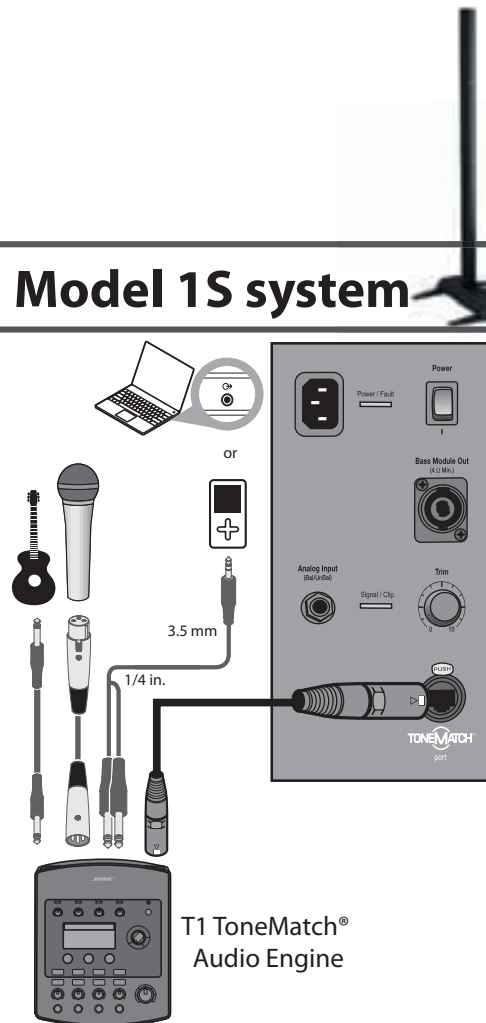

Sound Coverage

L1[®] Model 1S

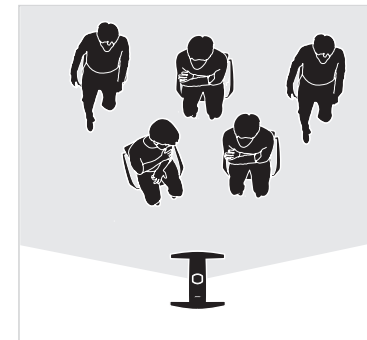

TOP

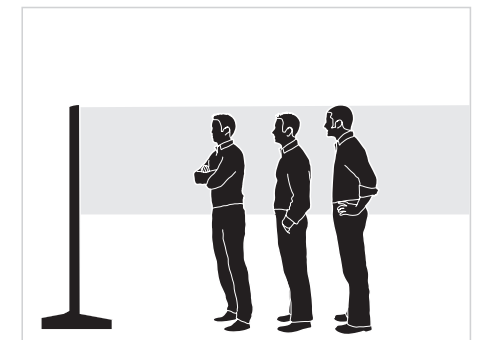

SIDE



TV



DVD/video



MP3 player



Laptop/PC



Microphone



Instrument



SMART Board
interactive whiteboard



Projector

L1[®] SYSTEMS FOR AUDIENCE SIZE: up to 500

L1[®] Model II portable line array system

Our most advanced system featuring our 24 speaker articulated line array providing our best tonal balance, coverage, and highest output.

The articulated 24-speaker line array provides 180 degrees of horizontal sound coverage while at the same time offering extremely tight vertical control resulting in less drop off in volume over distance than conventional loudspeakers.

The Model II power stand can drive two B1 bass modules or a single B2 bass module. It also features a dedicated bass line out allowing it to be used with the A1 PackLite[®] amplifier to add two additional B1 bass modules or an additional B2 bass module.

These durable components easily connect without the need for speaker stands or wires and are readily transported in four protective carry bags/covers. The materials and construction are specifically designed to meet the performance demands of a wide range of applications including musical performances, music playback, speeches and AV sound reproduction.

Bass Modules

Users have a choice between the B1, portable, lightweight bass module, or the B2, high-performance, flexible bass module.

T1 ToneMatch[®] Audio Engine

The addition of a T1 ToneMatch Audio Engine to any of the L1 systems provides four input channels with independent selection of ToneMatch presets and effects, including customized ToneMatch presets for a variety of popular microphones and instruments.

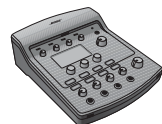

T1 ToneMatch[®]
Audio Engine

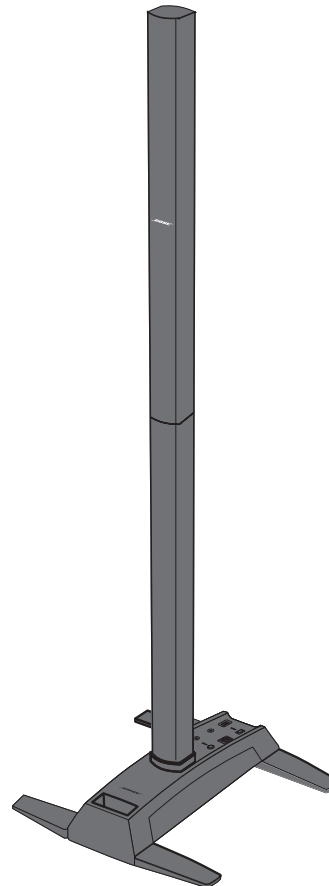

L1[®] Model II

Sound Coverage

L1[®] Model II

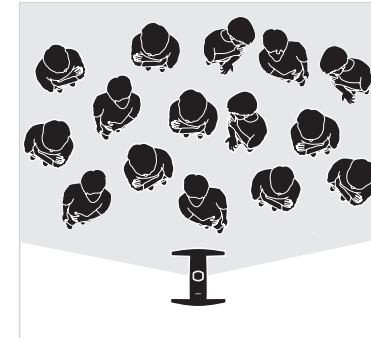

TOP

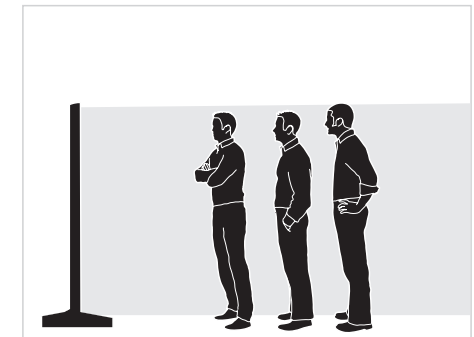

SIDE

L1® SYSTEMS FOR AUDIENCE SIZE: up to 500

Application example 1 — Voice Amplification

Applications

Plays and indoor performances

Emergency preparedness drills

Raffles, bingo games, or other events

Training exercises

Outdoor municipal auctions

Crowd control

L1 Model II system

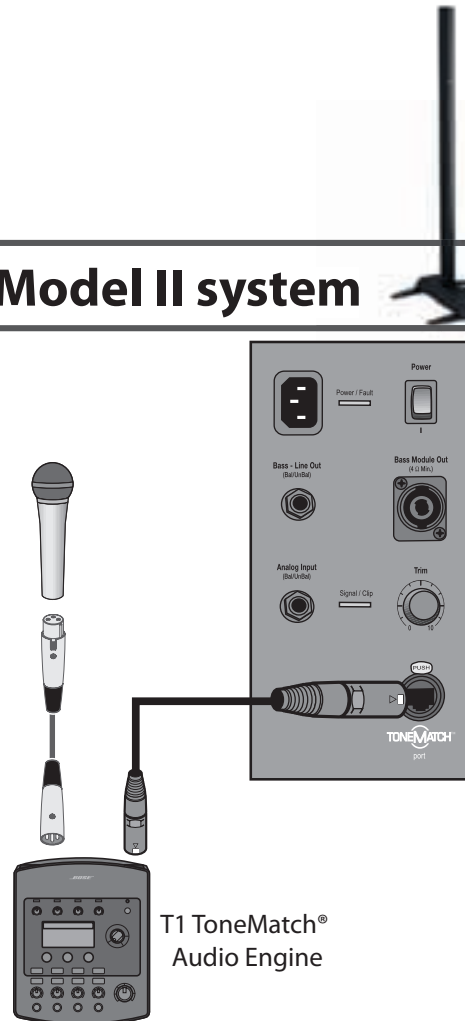

Sound Coverage

L1® Model II

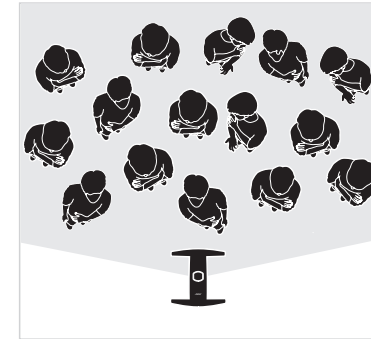

TOP

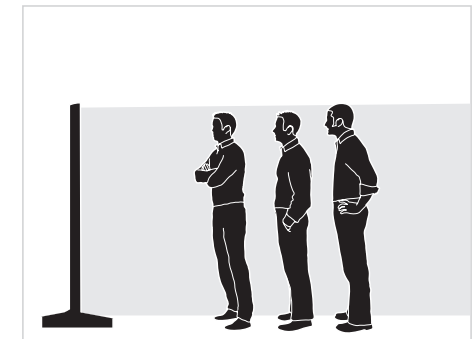

SIDE



TV



DVD/video



MP3 player



Laptop/PC



Microphone



Instrument



SMART Board
interactive whiteboard



Projector

L1[®] SYSTEMS FOR AUDIENCE SIZE: up to 500

Application example 2 — Music or Audio Playback

Applications

Outdoor cocktail party

Soundstage/sound effect (SFX)

L1 Model II system

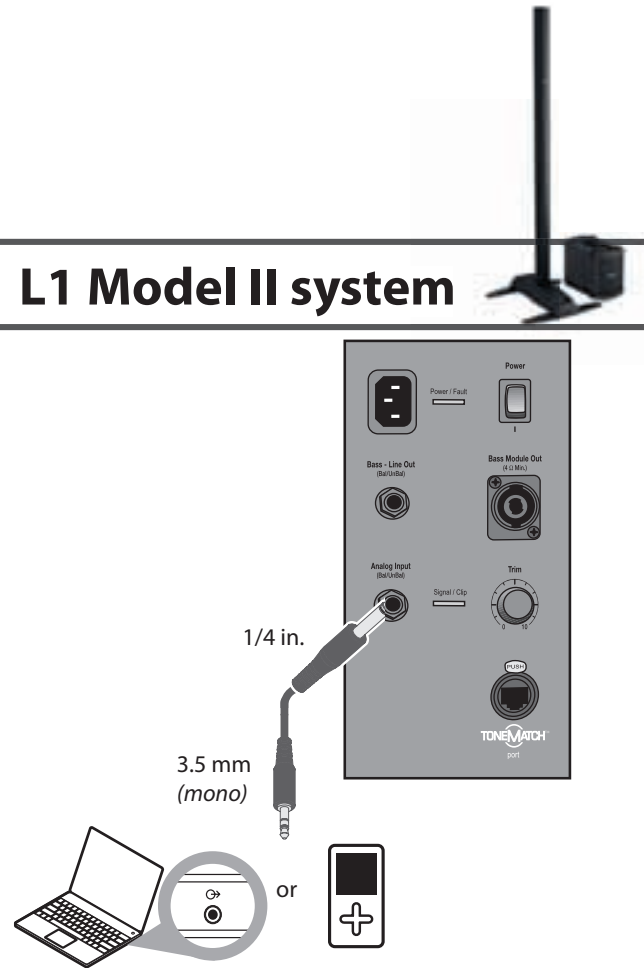

Sound Coverage

L1[®] Model II

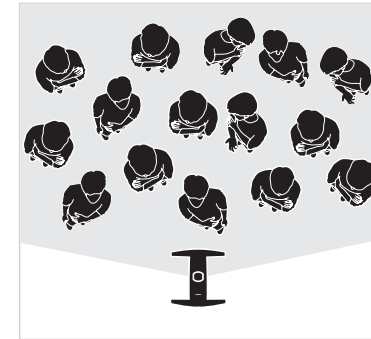

TOP

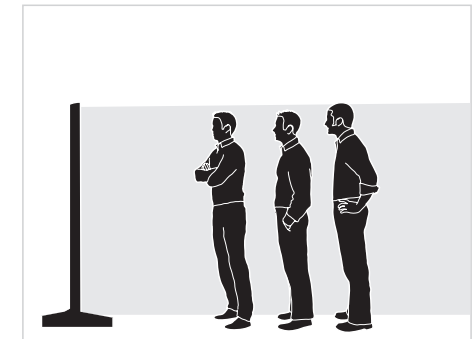

SIDE

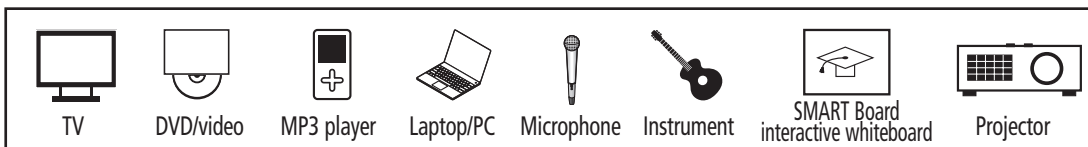

L1[®] SYSTEMS FOR AUDIENCE SIZE: up to 500

Application example 3 — Voice Amplification with Music or Audio Playback

Applications

Rallies, sporting events, speeches

Announcements and music at practices

Presentation or speech at a banquet or corporate meeting

Conference room meeting

Outdoor community events

Community theater

Fitness center gymnasium

Radio remote broadcast at a large concert or event

Outdoor amateur sports events

Theatrical production

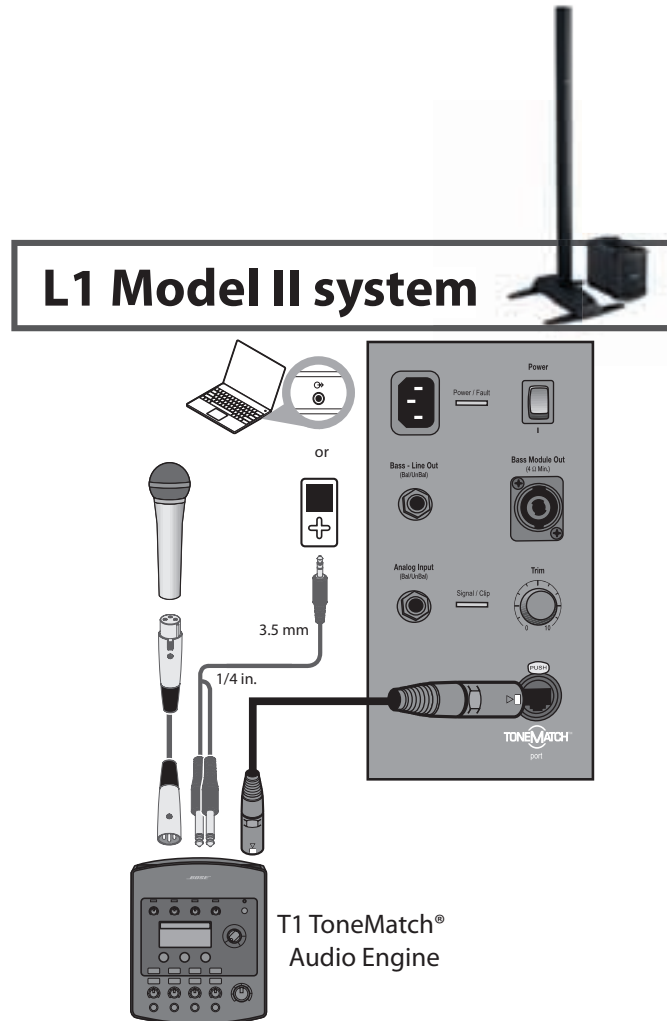

Sound Coverage

L1[®] Model II

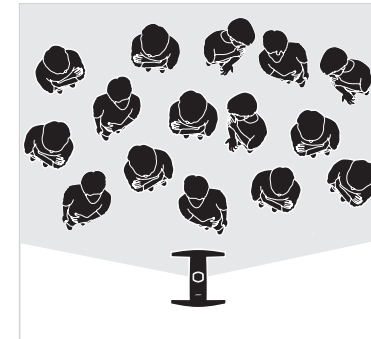

TOP

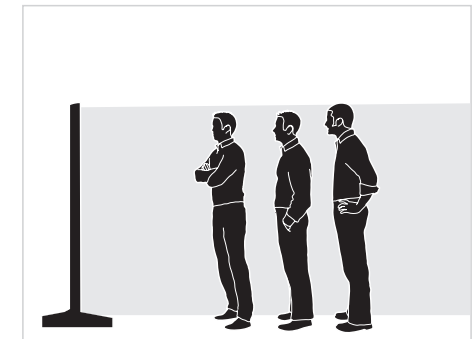

SIDE

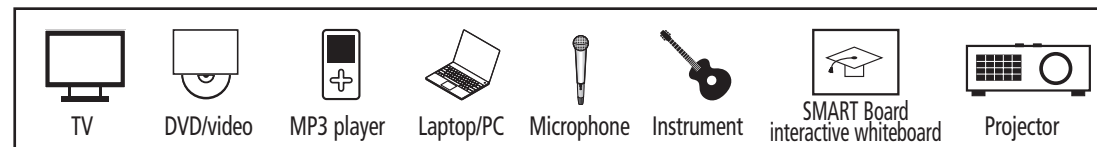

L1[®] SYSTEMS FOR AUDIENCE SIZE: up to 500

Application example 4 — Voice Amplification with Music or Audio Playback and Musical Instrument

Applications

Secondary PA for music worship, etc.

Community theater

Announcements and music at practices

Plays and indoor performances

L1 Model II system

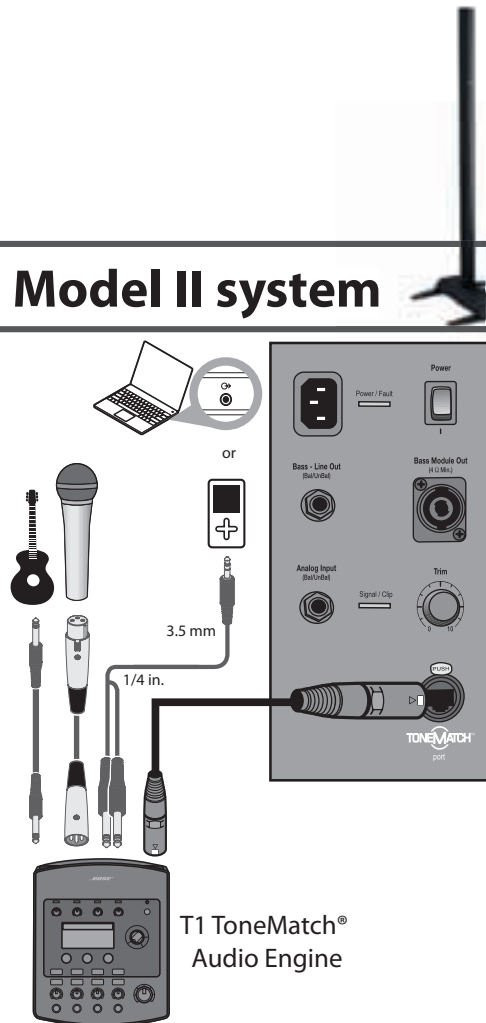

Sound Coverage

L1[®] Model II

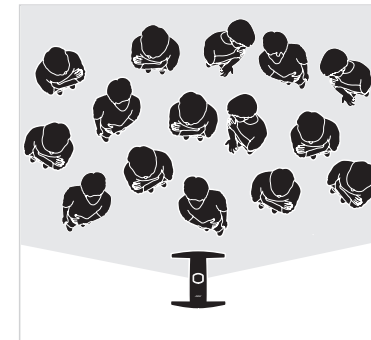

TOP

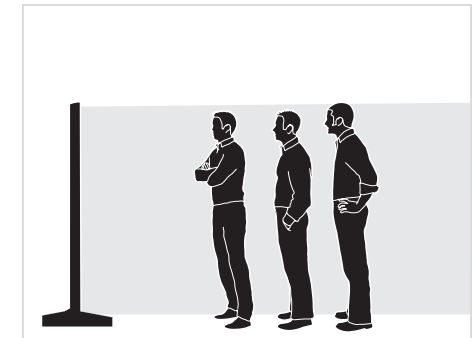

SIDE



TV



DVD/video



MP3 player



Laptop/PC



Microphone



Instrument



SMART Board
interactive whiteboard



Projector

L1[®] Bass Module Options

B1 bass module

Positioning

Portable lightweight bass module designed to provide deep balanced bass for Model 1S and Model II systems. It features 2 x 5.25" high excursion drivers built into a rugged enclosure. Interlocking end caps allow up to four B1 modules to be stacked together.

Includes slip cover and NL4 cable.

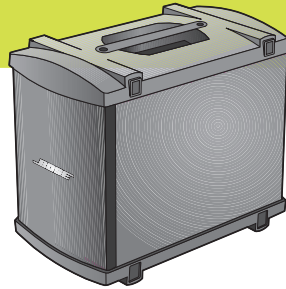

B2 bass module

Positioning

Our high performance flexible bass module designed to provide deep impactful bass for Model 1S and Model II systems used in higher SPL live music and DJ applications. It features 2 x 10" high excursion woofers mounted in a rugged plywood enclosure, and a three position sensing switch, allowing bass output to be adjusted for different applications. Interlocking end caps allow up to two B2 modules to be stacked together.

Includes slip cover and NL4 cable.

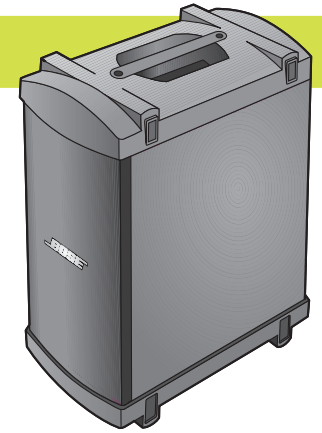

Input panel

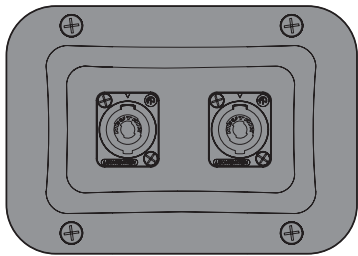

Input panel

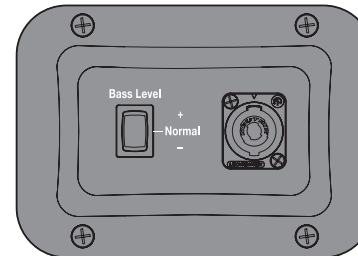

L1[®] System Configurations

L1[®] Model 1S with B1 bass module(s)

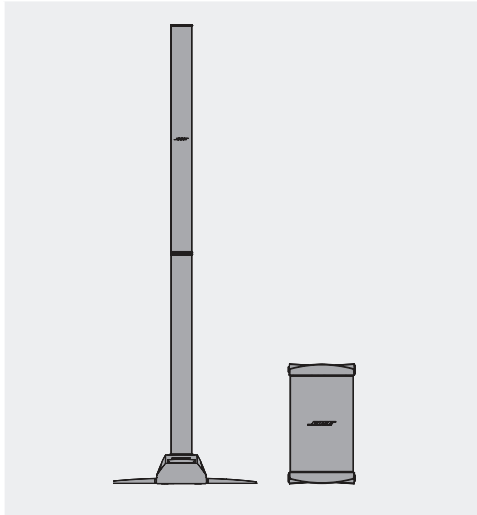

One B1 bass module

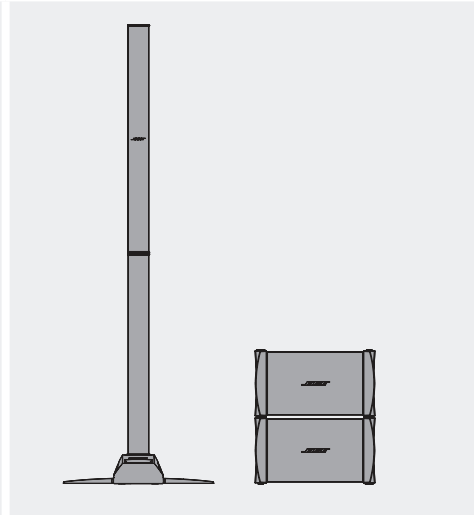

Two B1 bass modules

L1[®] Model 1S with B2 bass module

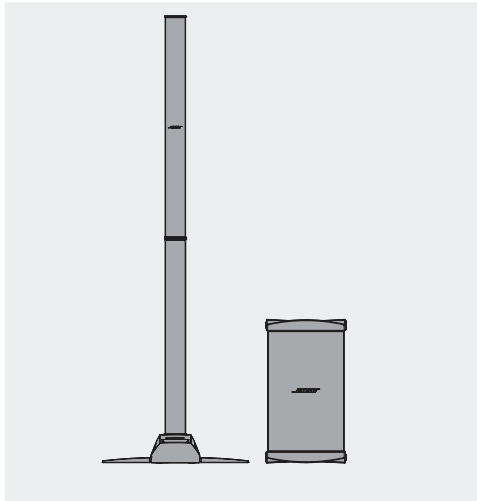

One B2 bass module

L1[®] System Configurations

L1[®] Model II with B1 bass module(s)

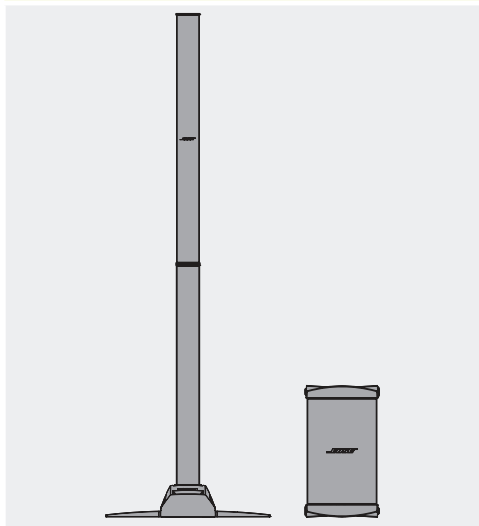

One B1 bass module

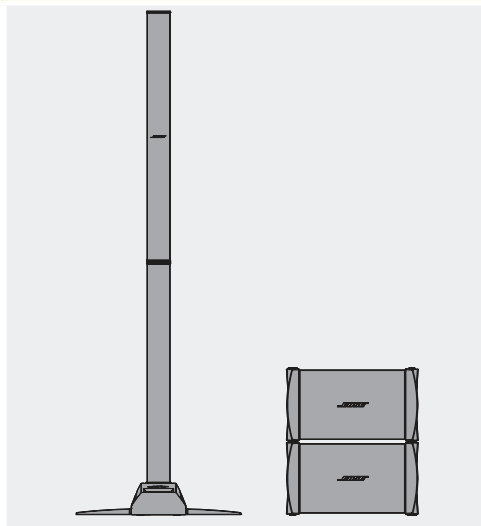

Two B1 bass modules

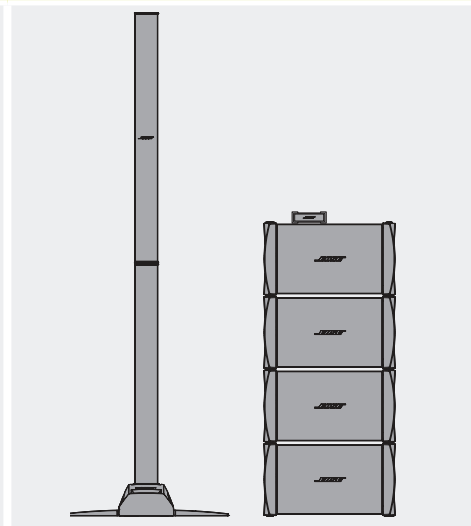

Four B1 bass modules (with PackLite[®])

L1[®] Model II with B2 bass module(s)

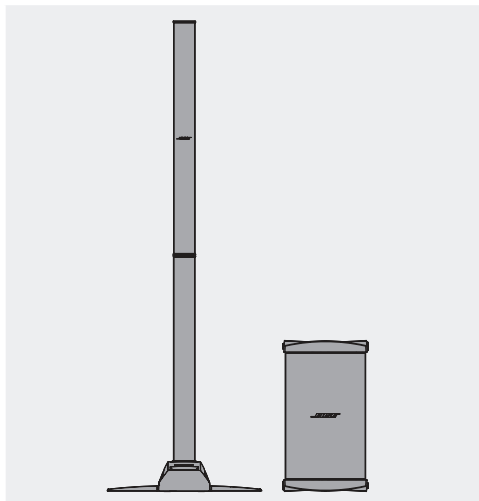

One B2 bass module

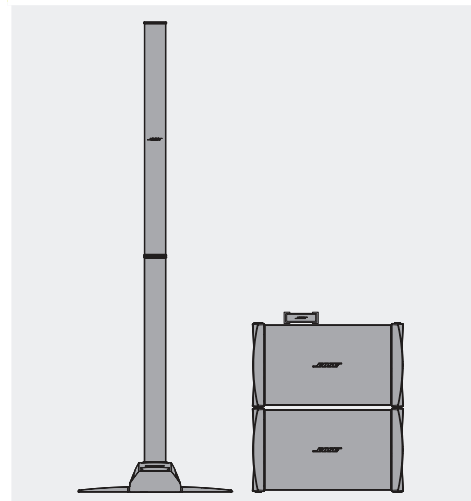

Two B2 bass modules (with PackLite)



BOSE[®]
Better sound through research[®]

©2012 Bose Corporation
The Mountain, Framingham, MA 01701-9168
AM357297 Rev. 00